

Digital Fiber Amplifier

E3X-DA-N

Truly ultimate fiber amplifier in pursuit of "user friendliness" and "high performance"



UL991*

* UL-listed including UL991 tests/evaluations Applicable standard: UL3121-1 Standards for additional tests/evaluations for applications: UL991, SEMI S2-0200

Features

Reducing power line wiring meaning space is saved. New design for easier maintenance.

Industry First Patent pending

The connector type that uses the wire-saving connector supplies power to the single-conductor slave connectors via the three-conductor master connector. Hence, the following three has been made possible.

1. Wiring is much simpler.
2. Relay connectors are not required meaning that space is used more efficiently and costs are reduced.
3. Simple inventory control because of no differentiation between master and slave in the amplifier section.

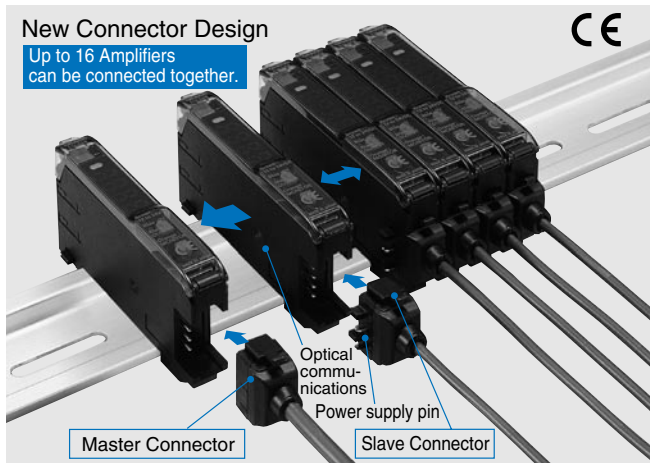

Super digital display by use of the Auto Power Control (APC) circuit

Industry First

The incident level of LEDs used in sensors is prone to deteriorate with time and as a result, detection becomes unstable. Using the APC (auto power control) circuit for the first time as the fiber sensor, the E3X-DA-N series has no digital value variations, realizing severe detection.

This makes the E3X-DA-N ideal for applications where a high degree of sensitivity is required, such as detecting crystal glass.

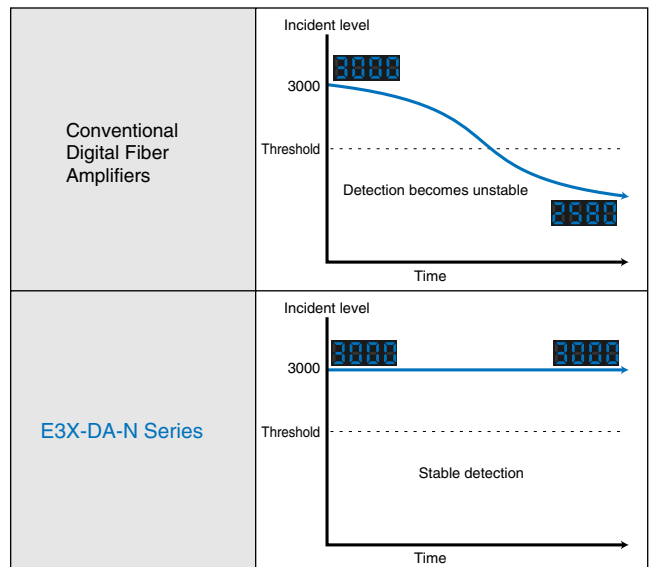

Power consumption reduced by 70%.

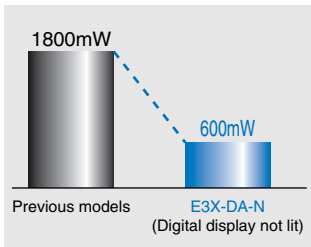

Power consumption has been reduced up to about 70% from 1800 mW to 600 mW. (If the digital display is off)



The digital display can be changed to full-OFF or Dark-ON during RUN.

Eco mode

Power consumption can be reduced by setting the display to Full-OFF/Dark-ON in applications where the digital display is rarely looked at during RUN.

(Can be set at the Mobile Console only)

Beeper-sized, new-generation Mobile Console unleashing the power of the ultimate fiber amplifier

Remote setting/adjustment function

Setting/teaching/fine adjustment can be made at the fiber front-end.

The Mobile Console has enabled setting and teaching at the fiber front-end, which could only be made at the amplifier. You can perform major adjustments while looking at the work position, etc.

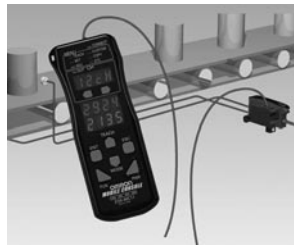

Simultaneous turning possible using group teaching.

While teaching had to be performed for each Amplifier separately, it can now be performed for several Amplifiers at once using the Mobile Console.

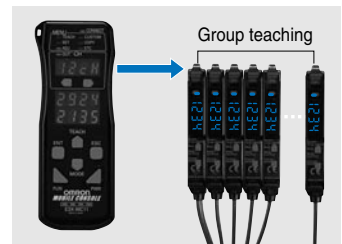

Differences in incident light avoided by group zero-reset.

The incident levels of several amplifiers can be batch-reset to zero by the group zero-reset. This feature is useful for reducing differences between the amplifiers.

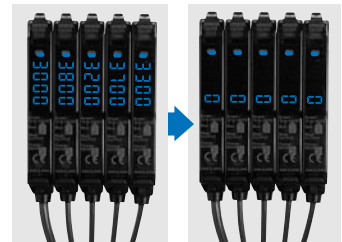

Incident level and threshold can be displayed simultaneously.

New Concept
Patent pending



Sensor head flashing during Amplifier operation Alternatively, the amplifier channel can be displayed.

If the amplifier being operated is away from the sensor head, the sensor head can be flashed or the amplifier channel can be displayed.





Ordering Information

Amplifier units

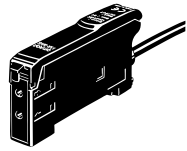
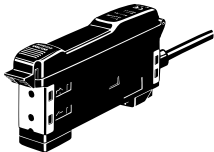
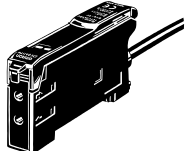
Prewired

Item	Shape	Control output	Model	
			NPN output	PNP output
Standard models		ON/OFF output	E3X-DA11-N	E3X-DA41-N
Monitor-output models		•ON/OFF output •Monitor output	E3X-DA21-N	E3X-DA51-N
Mark-detecting models (Blue LED)		E3X-DAB11-N	E3X-DAB41-N	
Mark-detecting models (Green LED)		E3X-DAG11-N	E3X-DAG41-N	
Infrared models		E3X-DAH11-N	E3X-DAH41-N	
Differential output type		E3X-DA11D	---	
Water-resistant models		ON/OFF output	E3X-DA11V	E3X-DA41V
Twin-output models			E3X-DA11TW	E3X-DA41TW

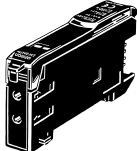

Connector type

Item	Shape	Applicable Connector (order separately)		Control output	Model	
					NPN output	PNP output
Standard models		Master	E3X-CN11	ON/OFF output	E3X-DA6	E3X-DA8
		Slave	E3X-CN12			
Monitor-output models		Master	E3X-CN21	•ON/OFF output •Monitor-output	E3X-DA7	E3X-DA9
		Slave	E3X-CN22			
Mark-detecting models (Blue LED)		Master	E3X-CN11	ON/OFF output	E3X-DAB6	E3X-DAB8
		Slave	E3X-CN12			
Mark-detecting models (Green LED)		Master	E3X-CN11		E3X-DAG6	E3X-DAG8
		Slave	E3X-CN12			
Infrared models		Master	E3X-CN11		E3X-DAH6	E3X-DAH8
		Slave	E3X-CN12			
Differential output type		Master	E3X-CN11		E3X-DA6D	---
		Slave	E3X-CN12			
Water-resistant models (M8 Connector)		XS3F-M421-40□-A XS3F-M422-40□-A			E3X-DA14V	E3X-DA44V
Twin-output models		Master	E3X-CN21		E3X-DA6TW	E3X-DA8TW
		Slave	E3X-CN22			

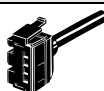
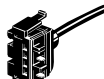



Amplifier units Connectors (Order Separately) Note: Stickers for Connectors are included as accessories.

Item	Shape	Cable length	No. of conductors	Model
Master connector		2 m	3	E3X-CN11
			4	E3X-CN21
Slave connector			1	E3X-CN12
			2	E3X-CN22

Sensor I/O Connectors (Order separately)

Size	Cable type	Shape	Cable length	Model	
M8	Standard cable	Straight connector 	2 m	4 conductors	XS3F-M421-402-A
			5 m		XS3F-M421-405-A
		L-shaped connector 	2 m		XS3F-M422-402-A
			5 m		XS3F-M422-405-A

Mobile Console (Order Separately)

Shape	Model	Remarks
	(Set form) E3X-MC11	Mobile Console with head, cable, and AC adapter provided as accessories. Power supply provided by chargeable battery
	E3X-MC11-C1	Mobile Console
	E3X-MC11-H1	Head
	E39-Z12-1	Cable (1.5 m)

In general, amplifier units and connectors are sold separately.

Refer to the following tables for order placement.

amplifier units			Applicable Connector (order separately)	
Type	NPN	PNP	Master connector	Slave connector
Standard models	E3X-DA6	E3X-DA8	E3X-CN11	E3X-CN12
Mark-detecting models	E3X-DAB6	E3X-DAB8		
	E3X-DAG6	E3X-DAG8		
Infrared models	E3X-DAH6	E3X-DAH8	E3X-CN21	E3X-CN22
Differential output	E3X-DA6D	---		
Monitor-output models	E3X-DA7	E3X-DA9		
Twin-output models	E3X-DA6TW	E3X-DA8TW		

When using 5 sets

amplifier units (5 Units)	+	1 Master Connector + 4 Slave Connectors
---------------------------	---	---

Rating/Performance

Amplifier units

Prewired

Item	Model	Type	Standard models	Monitor-out-put models	Mark-detecting models		Infrared models	Water-resis- tant models	Twin-output models
		NPN output	E3X-DA11-N	E3X-DA21-N	E3X-DAB11-N	E3X-DAG11-N	E3X-DAH11-N	E3X-DA11V	E3X-DA11TW
		PNP output	E3X-DA41-N	E3X-DA51-N	E3X-DAB41-N	E3X-DAG41-N	E3X-DAH41-N	E3X-DA41V	E3X-DA41TW
Light source (wave length)			Red LED (660 nm)		Blue LED (470 nm)	Green LED (525 nm)	Infrared LED (870 nm)	Red LED (660 nm)	
Power supply voltage			12 to 24 VDC ±10%, ripple (p-p) : 10% max.						
Power consumption			Normal: Power consumption 960 mW max. (power consumption 40 mA max. at supply voltage 24 V) Eco mode: Power consumption 720 mW max. (power consumption 30 mA max. at supply voltage 24 V) Digital display OFF: Power consumption 600 mW max. (power consumption 25 mA max. at supply voltage 24 V)						
Con- trol output	ON/OFF output		Load current 50 mA (residual voltage NPN/PNP: 1 V max. each) Open collector output type (depends on the NPN/PNP output format) Light-ON/Dark-ON, switch selectable						
	Monitor output		---	1 to 5 VDC, load 10 k min.	---				
Protective circuits			Reverse polarity protection, output short-circuit protection, mutual interference prevention (possible for up to 10 amplifiers)						
Re- spon- se time	Super-high- speed mode:		0.25 ms for operation and reset respectively					0.5 ms for operation and reset respectively	
	Standard mode:		Operation/reset: 1 ms each					2 ms for operation and reset respectively	
	Super-long-dis- tance mode:		4 ms for operation and reset respectively					7 ms for operation and reset respectively	
Sensitivity setting			Teaching or manual method						
Func- tions	Timer functions		OFF delay 0 to 200 ms (1 to 20: 1 ms increments, 20 to 200 ms: 5 ms increments), when the Mobile Control is used, select either OFF delay, ON delay or one shot.						
	Automatic pow- er control (APC)		Fiber-optic current digital con- trol			---		Fiber-optic current digital control	
	Zero reset		Yes (negative indication possible)						
	Initial reset		Yes (setting conditions initialized)						
	Monitor focus		---	Upper and lower limit val- ues of output range can be set per digital value of 100		---			
Indicator lamp			Operation indicator (orange), 7-segment digital incident level display (red), 7-segment digital incident level percent display (red), incident level & threshold value double-bar display (green, red), 7-segment digital threshold value display (red)						
Display timing			Normal/peak hold/bottom hold selectable						
Display direction			Normal/reverse selectable						
Optical axis adjustment function			Yes (hyper flashing emission function)						
Ambient lighting			Incandescent lamp: 10,000 lux max. Sunlight 20,000 lux max.						
Ambient temperature			Operating: Groups of 1 to 3 amplifiers: -25 to +55°C, Groups of 4 to 11 amplifiers: -25 to +50°C, Groups of 12 to 16 amplifiers: -25 to +45°C Storage: -30 to +70°C (with no icing and condensation)						
Ambient humidity			Operating/Storage: 35% to 85% RH (with no condensation)						

Item	Model	Type	Standard models	Monitor-out-put models	Mark-detecting models		Infrared models	Water-resis- tant models	Twin-output models
		NPN output	E3X-DA11-N	E3X-DA21-N	E3X-DAB11-N	E3X-DAG11-N	E3X-DAH11-N	E3X-DA11V	E3X-DA11TW
		PNP output	E3X-DA41-N	E3X-DA51-N	E3X-DAB41-N	E3X-DAG41-N	E3X-DAH41-N	E3X-DA41V	E3X-DA41TW
Insulation resistance		20 M min. at 500 VDC							
Dielectric strength		1,000 VAC at 50/60 Hz for 1 minute							
Vibration resistance		10 to 55 Hz, 1.5 mm double amplitude for 2 hours each in X, Y, and Z directions							
Shock resistance		Destruction: 500 m/s ² for 3 times each in X, Y, and Z directions							
Degree of protection		IEC 60529 IP50 (with Protective Cover attached)						IEC 60529 IP66 (with protective cover at- tached)	IEC 60529 IP50 (with protective cover attached)
Connection method		Prewired models (standard length: 2 m)							
Weight (Packed state)		Approx. 100 g						Approx. 110 g	Approx. 100 g
Material	Case	PBT (polybutylene terephthalate)							
	Cover	Polycarbonate						Polyethersul- fone	
Accessories		Instruction manual							

Connector type

Specifications that differ from those of the prewired type

Item	Model	Type	Standard models	Monitor-out-put models	Mark-detecting models		Infrared models	Water-resis- tant models (See note.)	Twin-out- put models
		NPN output	E3X-DA6	E3X-DA7	E3X-DAB6	E3X-DAG6	E3X-DAH6	E3X-DA14V	E3X-DA6TW
		PNP output	E3X-DA8	E3X-DA9	E3X-DAB8	E3X-DAG8	E3X-DAH8	E3X-DA44V	E3X-DA8TW
Connection method		Connector type						M8 connector	Connector
Weight (Packed state)		Approx. 55 g						65 g	Approx. 55 g

* For waterproof type only, voltage resistance is 500 VAC 50/60 Hz 1 min

Amplifier unit Connectors

Item	Model	E3X-CN11/21/22	E3X-CN12
Rated current	2.5 A		
Rated voltage	50 V		
Contact resistance	20 m max. (20 mVDC max., 100 mA max.) [By connection with amplifier unit and connection with adjacent connector (except conductor resistance of cable)]		
No. of insertions	50 times (By connection with amplifier unit and connection with adjacent connector)		
Material	Housing	PBT (polybutylene terephthalate)	
	Contacts	Phosphor bronze/gold-plated nickel	
Weight (Packed state)	Approx. 55 g		Approx. 25 g

Mobile Console

Item	Model	E3X-MC11
Supply volt- age	Charged with AC adapter	
Connection method	Connected via adapter	
Weight (packed state)	Approx. 580 g (Console only: 120 g)	

For details of the Mobile Console, refer to the instruction manual attached to the product.

Digital Fiber Amplifier

* Differential output digital fiber amplifier (E3X-DA11D/E3X-DA6D)

Applicable fiber unit characteristic

(Through-beam model)

Sensitivity switching 11 steps can be set	Sensing distance (mm) (Values in parentheses: When using the E39-F1 lens unit)						Standard object (mm) *1 Minimum sensing object *2 (Opaque object) default
	HIGH			LOW			
	1	2	3-11	1	2	3-11	
Fiber type	270 or 570 s	0.5 or 1 ms	1 to 200 ms or 2 to 400 ms	270 or 570 s	0.5 or 1 ms	1 to 200 ms or 2 to 400 ms	
E32-ET11R	240 (1680)	280 (1960)	370 (2590)	140(980)	180(1260)	240 (1680)	1 mm dia. (0.01 mm dia.)
E32-ET21R	50	60	80	30	40	50	(0.3 mm dia.)*3
E32-T16WR	580	690	910	350	450	580	(0.2 mm dia.)
E32-T16PR	380	450	600	230	290	380	

*1. The sensing object is operating.

*2. Value applied when the response time is set to 3-11. The value can be detected if the temperature varies within the operating ambient temperature. (Value when the sensing object is operating)

*3. The digital value is 1000 and the value can be detected in each detection area. Refer to the E3X-DA-N for the note of the fiber unit.

(Reflective model)

Sensitivity switching 11 steps can be set	Sensing distance (mm)*1						Standard object (mm) *2 Minimum sensing object *3 (Opaque object) default
	HIGH			LOW			
	1	2	3-11	1	2	3-11	
Fiber type	270 or 570 s	0.5 or 1 ms	1 to 200 ms or 2 to 400 ms	270 or 570 s	0.5 or 1 ms	1 to 200 ms or 2 to 400 ms	
E32-ED11R	80	90	120	45	60	80	150 x 150 (0.01 mm dia.)
E32-ED21R	13	15	20	7	10	13	25 x 25 (0.01 mm dia.)

*1. Sensing distance indicates values for white paper.

*2. The sensing object is operating.

*3. Value applied when the response time is set to 3-11. The value can be detected if the temperature varies within the operating ambient temperature. (Value when the sensing object is operating)

Note: Refer to E3X-DA-N for the note of the fiber unit.

Differences from E3X-DA-N amplifier unit

Item		Differential output type (edge detection type)	
		Prewiring type	amplifier units with Connectors
NPN output		E3X-DA11D	E3X-DA6D
Power consumption		Power consumption 960 mW max. (at power supply voltage 24 V, power consumption 40 mA max.)	
Control output	ON/OFF output	Load current 50 mA (residual voltage NPN/PNP: 1 V max. each) Open collector output type L.ON (ON at edge detection)/D.ON (OFF at edge detection) switch selectable	
Detection mode		One-side edge detection mode/both-side edge detection mode	
Response time		One-side edge detection mode: 270/500 s/1/2/4/10/20/30/50/100/200 ms selectable Both-side edge detection mode: 570 s/1/2/4/10/20/30/50/100/200/400 ms selectable	
Func-tions	Timer function	OFF delay timer for L.ON ON delay timer for D.ON 0 to 5 s (1 to 20 ms: 1 ms increments, 20 to 20 ms: 5 ms increments, 200 ms to 1 s: 100 ms, 1 to 5 s: 1 s increments)	
	APC	Yes	
	Zero reset	Yes (negative indication)	
	Initial reset	Yes (setting conditions initialized)	
	Sensitivity switching	Yes (HIGH/LOW)	
Teaching level		One-point teaching level 1 to 50% variable (1% increments)	
Indicator lamp		Operation indicator (orange), 7-segment incident level display (red), 7-segment digital edge detection level display (red)	

For the outline drawings and other details, refer to the instruction manuals attached to the products.

Output Circuit Diagram

NPN output

Model	Output transistor Status	Timing chart	Mode selection switch	Output circuit
E3X-DA11-N E3X-DAB11-N E3X-DAG11-N E3X-DAH11-N E3X-DA11V E3X-DA6 E3X-DAB6 E3X-DAG6 E3X-DAH6 E3X-DA14V	Light ON		L ON (LIGHT ON)	<p>Connector Pin Arrangement</p> <p>Note: Pin 2 is not used.</p>
	Dark ON		D ON (DARK ON)	
E3X-DA21-N E3X-DA7	Light ON		L ON (LIGHT ON)	<p>Note: Load resistance: 10Ωmin.</p>
	Dark ON		D ON (DARK ON)	
E3X-DA11TW E3X-DA6TW	Light ON		L ON (LIGHT ON)	
	Dark ON		D ON (DARK ON)	

Note: With E3X-DA□TW models, only channel 1 is output when set for area sensing operation.
 L ON The range between the CH1 and CH2 thresholds turns ON
 D ON The range between the CH1 and CH2 thresholds turns OFF (CH2 is always OFF)

E3X-DA-N

PNP output

Model	Output transistor Status	Timing chart	Mode selection switch	Output circuit
E3X-DA41-N E3X-DAB41-N E3X-DAG41-N E3X-DAH41-N E3X-DA41V E3X-DA8 E3X-DAB8 E3X-DAG8 E3X-DAH8 E3X-DA44V	Light ON		L ON (LIGHT ON)	<p>Connector Pin Arrangement</p> <p>Note: Pin 2 is not used.</p>
	Dark ON		D ON (DARK ON)	
E3X-DA51-N E3X-DA9	Light ON		L ON (LIGHT ON)	<p>Note: Load resistance: 10kΩmin.</p>
	Dark ON		D ON (DARK ON)	
E3X-DA41TW E3X-DA8TW	Light ON		L ON (LIGHT ON)	
	Dark ON		D ON (DARK ON)	

Note: With E3X-DA□TW models, only channel 1 is output when set for area sensing operation.
 L ON The range between the CH1 and CH2 thresholds turns ON
 D ON The range between the CH1 and CH2 thresholds turns OFF (CH2 is always OFF)

Connectors (Sensor I/O Connectors)

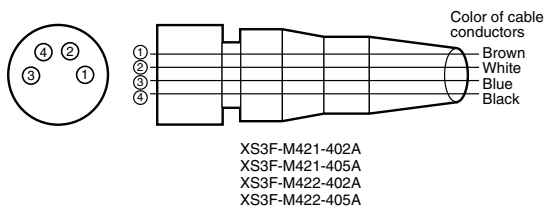

Class	Wire, outer jacket color	Connector pin No.	Application
For DC	Brown	①	Power supply (+V)
	White	②	-
	Blue	③	Power supply (0 V)
	Black	④	Output

Note: Pin 2 is open.

Characteristic data (default)

Hysteresis vs. sensing distance

Reflective model
E32-D11L

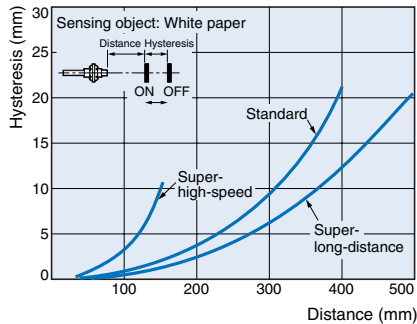

Repeated accuracy vs. sensing distance

Reflective model
E32-DC200

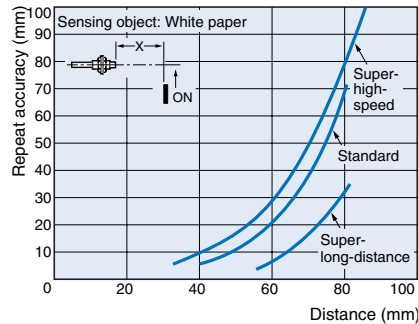

Monitor output vs. distance

(In standard mode)

Through-beam
E32-TC200

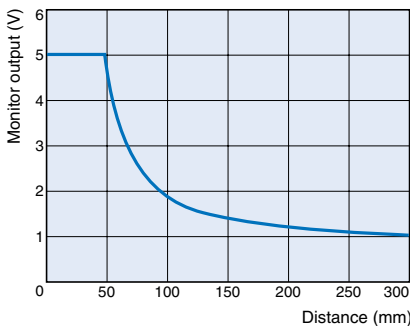

Reflective model
E32-DC200

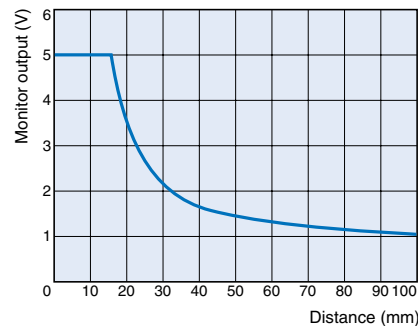

Connection

Connection with linear sensor controller K3NX-VD2

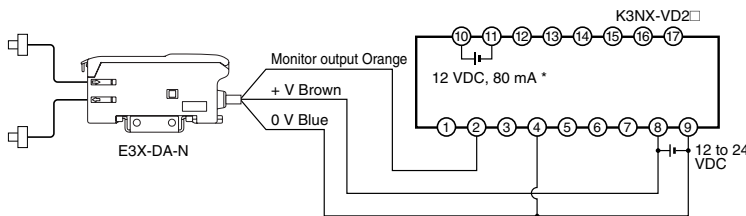

- * Use this service power supply for the Sensor with reference to the power consumption of each Sensor.
- Note: 1. Various I/O Units are available for the K3NX. Select an appropriate output type depending on the application.
- 2. For details about the K3NX, refer to the K3NX Datasheet (N084) or the K3NX Operation Manual (N90).
- 3. This wiring is for the K3NX, with DC power supply specifications and the Monitor (Analog) Sensor with DC power supply specifications. Check respective power supply specifications before wiring them.

Nomenclature:

amplifier units

Standard, monitor-output, mark-detecting, infrared, and water-resistant models

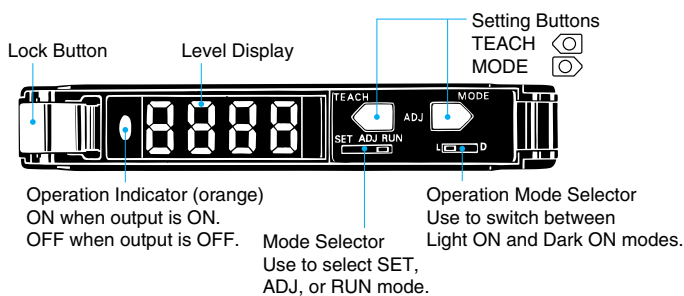

Twin-output models

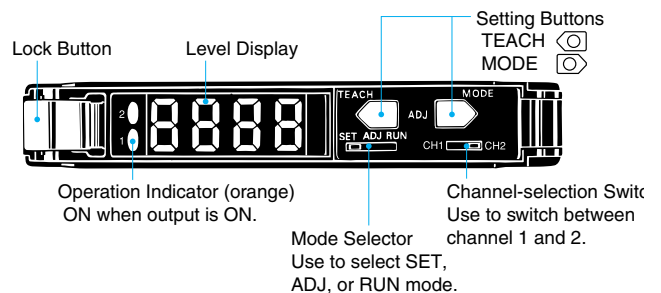

Operation

General

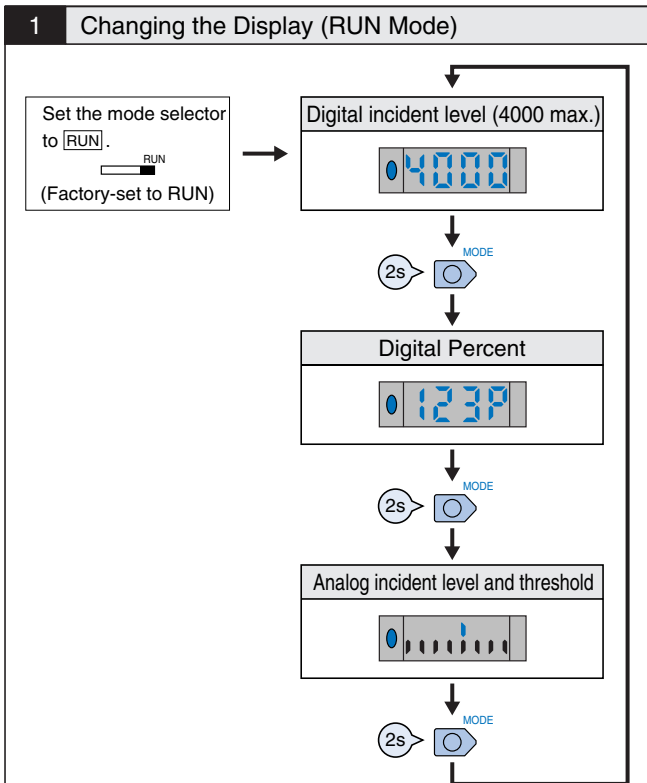

● **Manual Tuning (Fine Sensitivity Adjustment) in ADJ Mode**
 Perform fine sensitivity adjustment after teaching and manual tuning (without using the teaching function) in the way shown below:

Twin-output Models
 Select the channel to be adjusted using the channel selection switch.
 CH1 CH2



The items displayed in ADJ mode vary with the display setting in RUN mode.

RUN mode	ADJ mode
Digital incident level	Digital threshold
Digital percent	Digital Percent
Analog value	Analog value

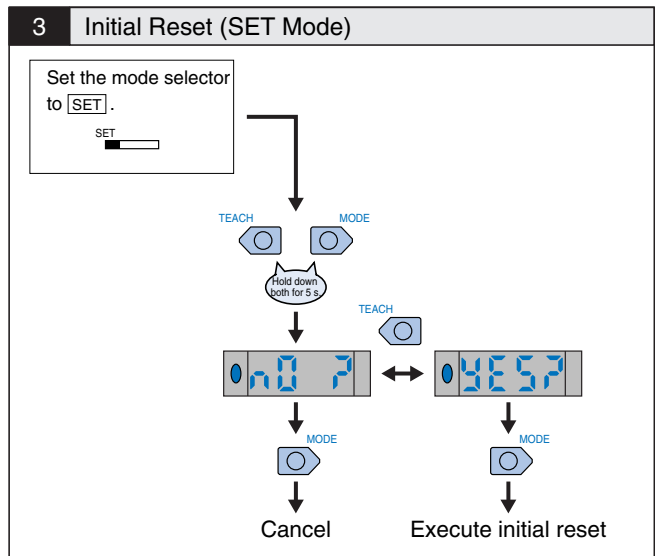
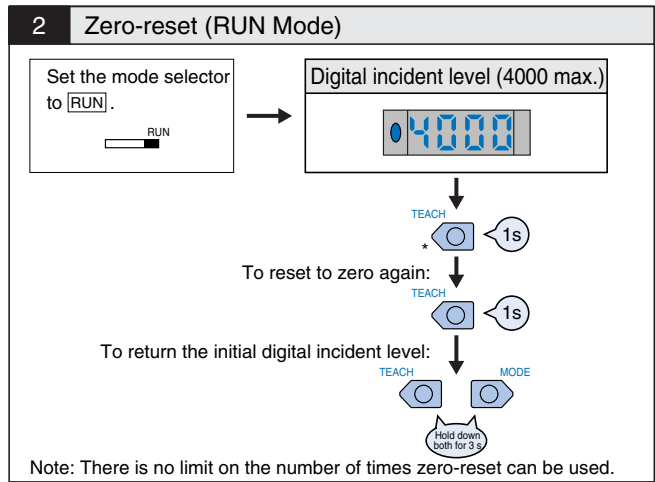

4 Setting Functions in SET Mode

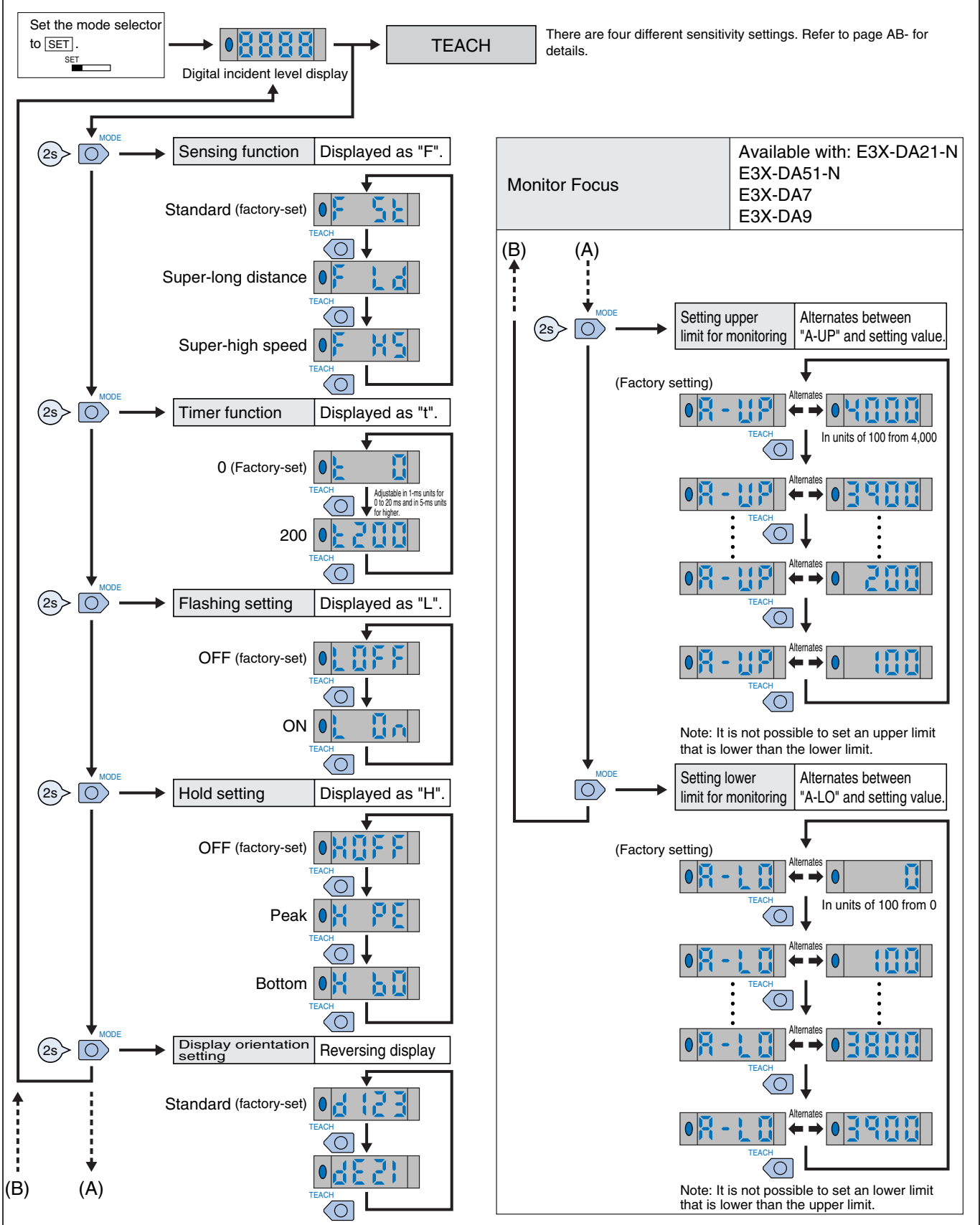

Twin-output models

4 Setting Functions in SET Mode

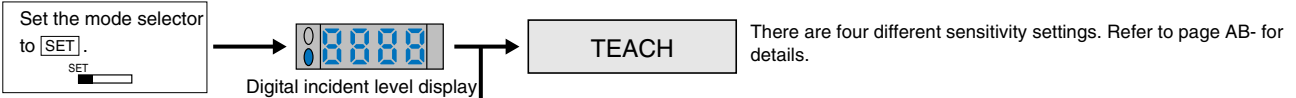

Setting the operating mode Changing the operating mode

The operating mode for the channel set with the channel-selection switch can be changed.

Changed using the channel-selection switch CH1 CH2

Channel 1 Channel 2

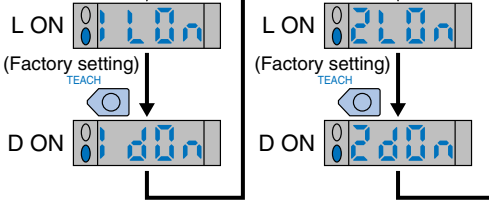

Sensing function Displayed as "F".

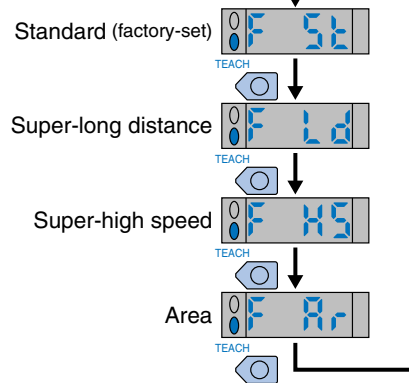

Area Sensing

Area sensing is possible using the threshold values for channels 1 and 2.

- If channel 1 is set to L/ON, output turns ON when the incident level is between the thresholds.
- If channel 1 is set to D/ON, output turns OFF when the incident level is between the thresholds.

The result is output to control output 1. (Control output 2 is always OFF.)

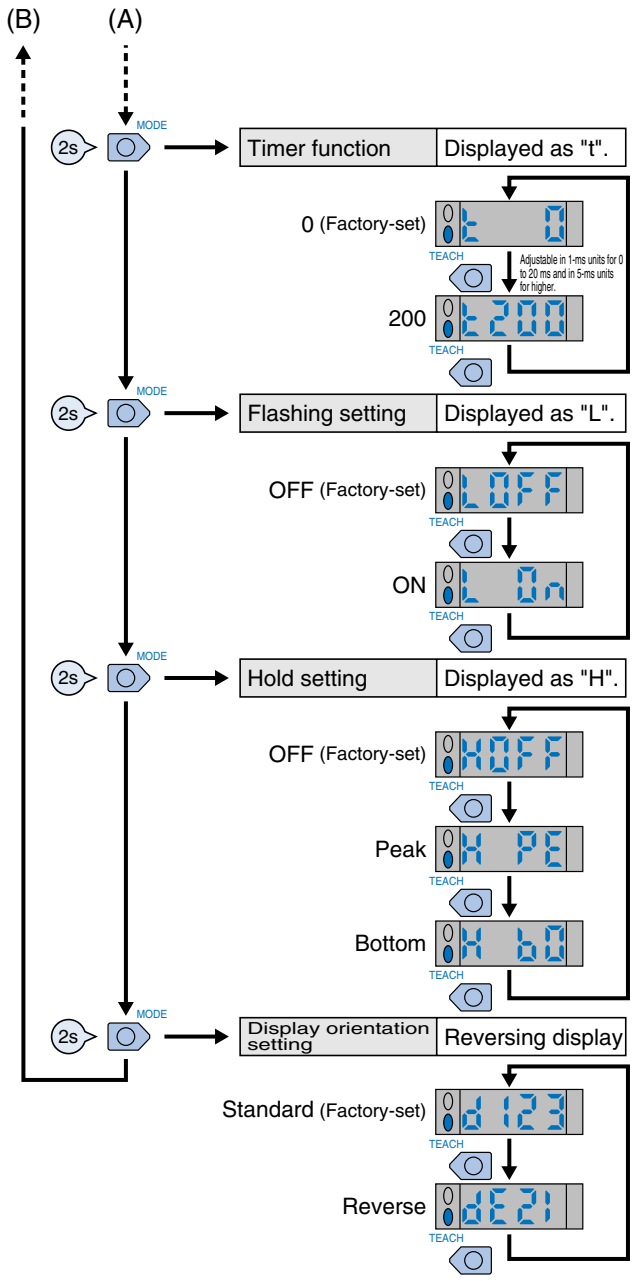

General



When teaching is performed (SET mode)

- The four types of teaching given below are available.
- Once setting is made, operation is performed in the preset status thereafter. When a teaching error occurs, the level indicators flash in red. Restart setting from the beginning.

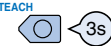
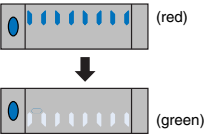

Twin-output models only Select the channel to be adjusted using the channel selection switch. CH1 CH2

Set the mode selector to SET

Maximum Sensitivity Setting

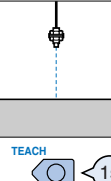

Procedure	Operation
1	Set the mode selector to SET. 
2	Press the TEACH button for 3 seconds min. 
3	Setting is completed when the red-lit level indicators turn to green. Then they return to the digital incident level display. 
4	Set to RUN mode. 

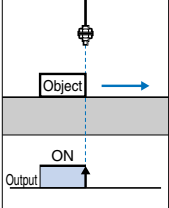
One-point without-object teaching

Procedure	Operation
1	Set the mode selector to SET. 
2	Press the SET button once (about 1 s). 
3	Setting is completed when the red level indicators are turned ON. They then return to the digital incident level display. 
4	Set to RUN mode. 
5	The threshold is automatically set with the object. 





Note: If one-point teaching is not available because the difference in level is too fine, try two-point teaching.

Operation Mode Selector

Operating mode	Operation
Light ON L ON	 (Factory-set)
Dark ON D ON	 D

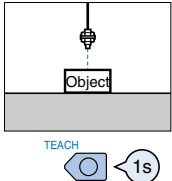

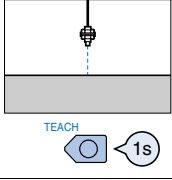

There is no operation mode selector for twin-output models.

Two-point With/Without-object Teaching

Procedure	Operation
1	Set the mode selector to SET. 
2	With the work present, press the SET button once (about 1 s). 
3	The level indicators are lit red. 
4	If no work is pending, press the SET button once (about 1 s). 
5	Setting is completed when the green indicators are turned ON. Then they return to the digital incident level display. 
6	Set to RUN mode. 

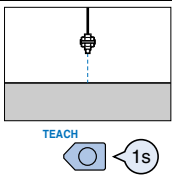
Note: With and without work may be in any order.

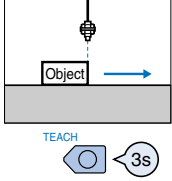
Pin-point teaching (for positioning)

Procedure	Operation
1	Set the mode selector to SET. 
2	If no work is pending, press the SET button once (about 1 s). 
3	The level indicators are lit red. 
4	Place the object in the desired position, and press the TEACH button for 3 seconds min. 
5	Setting is completed when the green indicators are turned ON. Then they return to the digital incident level display. (Red indicators start flashing if setting is not OK.) 
6	Set to RUN mode. 

Precautions

Correct Use

Amplifier units

Design

Power ON

The sensor is ready to sense an object within 200 ms after turning the power ON. If the load and sensor are connected to different power supplies, always turn on the sensor power first.

Mounting

Connection/removing of amplifier units

(Connection)

1. Install the units one by one to the DIN rail.

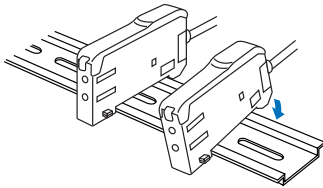

2. Slide one unit toward the other, match the clips at the front ends, and then bring them together until they "click".

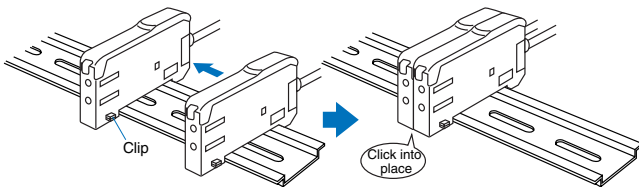

(Removing)

Slide one unit away from the other and remove them one by one. (Do not remove the connected units together from the DIN rail.)

Note: 1. When the amplifier units are connected to each other, the operable ambient temperature changes depending on the number of connected amplifier units. Check "Ratings/Performance".
 2. Before connecting or removing the units, always switch power off.

Fitting of Mobile Console head

When fitting the Mobile Console head, a 20 mm or more clearance is needed on the left side.

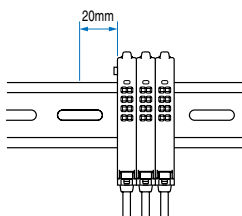

Use of Mobile Console

For the twin output type (E3X-DA□□TW), up to 16 channels (eight E3X-DA□□TW units) can be set from the Mobile Console E3X-MC11. (Note that the operation mode and area detection cannot be set.)

Adjustment

Mutual interference prevention function

The digital display value may vary due to the light from the other sensor. In that case, low the sensitivity (raise the threshold) to stabilize detection.

EEPROM Write Error

If a write error occurs (operation indicator starts flashing) due to power-off, static electricity or other noise in the teaching mode, perform teaching again.

Optical communication

When connecting the amplifier units, assemble them in close contact. During operation, do not slide or dismantle the amplifier units.

Hysteresis adjustment

The Mobile Console allows hysteresis adjustment, but note that the unit may not operate properly if the hysteresis setting is lower than the factory value.

Amplifier Unit Connectors

Installation

Connector installation

1. Insert the Master or Slave Connector into the amplifier unit until it clicks into place.

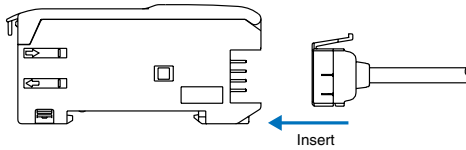

2. Link amplifier units to each other after the master and slave Connectors have been inserted.
3. Apply the supplied seal to the non-connecting surface of the master/slave connector.

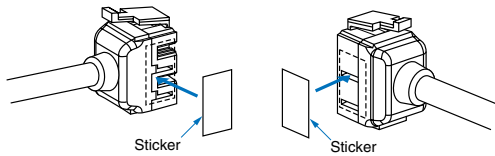

Note: Apply seal to the grooved side.

Removing Connectors

1. Slide the slave amplifier unit (s) on which the connector must be removed from the rest of the group.
2. After the amplifier unit (s) has been separated, press down the lever on the connector and remove it. (Do not attempt to remove connectors without separating them from other amplifier units first.)

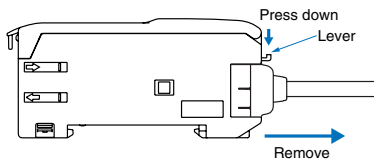

Mounting End Plate (PFP-M)

Depending on the installation, an amplifier unit may move during operation. In this case, use an end plate.

Before installing an end plate, remove the clip from the master amplifier unit using a nipper or similar tool.

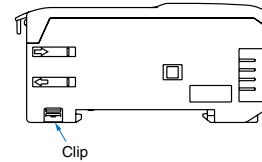

The sensor bottom is also equipped with a clip removing mechanism.

1. Insert the clip to be removed into the slit underneath the clip on another amplifier unit.

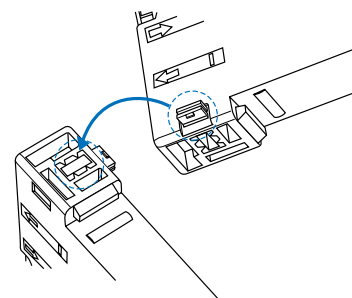

2. Remove the clip by rotating the amplifier unit.

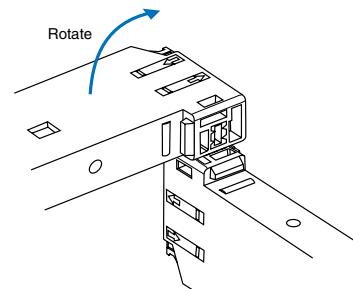

When fitting the Mobile Console, set the end plate in the guide as shown in the following figure.

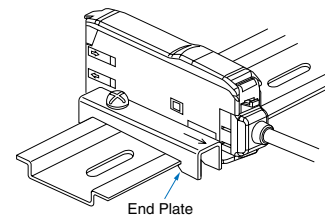

Tensile stress for connectors (including cables)

E3X-CN11, E3X-CN21, E3X-CN22: 30 N max.

E3X-CN12: 12N max.

Dimensions (Unit: mm)

Amplifier Units

prewired

E3X-DA11-N E3X-DAG11-N E3X-DA21-N
 E3X-DAH11-N E3X-DAB11-N E3X-DAB41-N
 E3X-DA41-N E3X-DAG41-N E3X-DA51-N
 E3X-DAH41-N E3X-DA11D

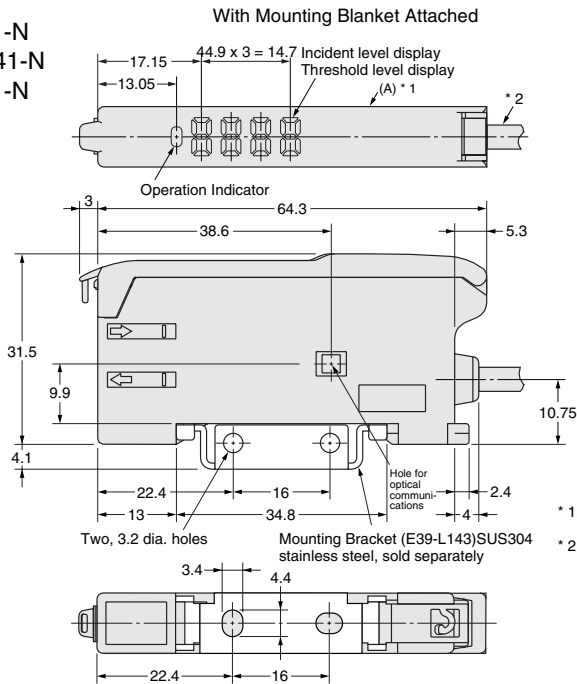
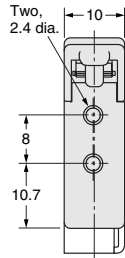
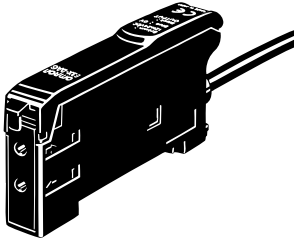

Mounting Holes

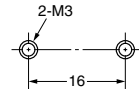

- * 1. The Mounting Bracket can also be used on side A.
- * 2. E3X-DA11-N/DA41-N/DAB11-N: A 4-dia., 3-conductor, vinyl-insulated round cable (conductor cross-sectional area: 0.45 mm²; insulation diameter: 1.1 mm) is used. E3X-DA21-N/DA51-N: A 4-dia., 4-conductor, vinyl-insulated round cable (conductor cross-sectional area: 0.2 mm²; insulation diameter: 1.1 mm) is used.

Amplifier units with Cables, Water-resistant Models

E3X-DA11V
 E3X-DA41V

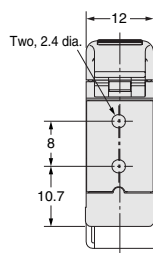
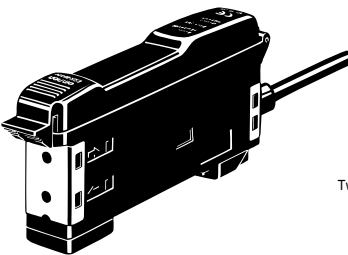

Mounting Holes

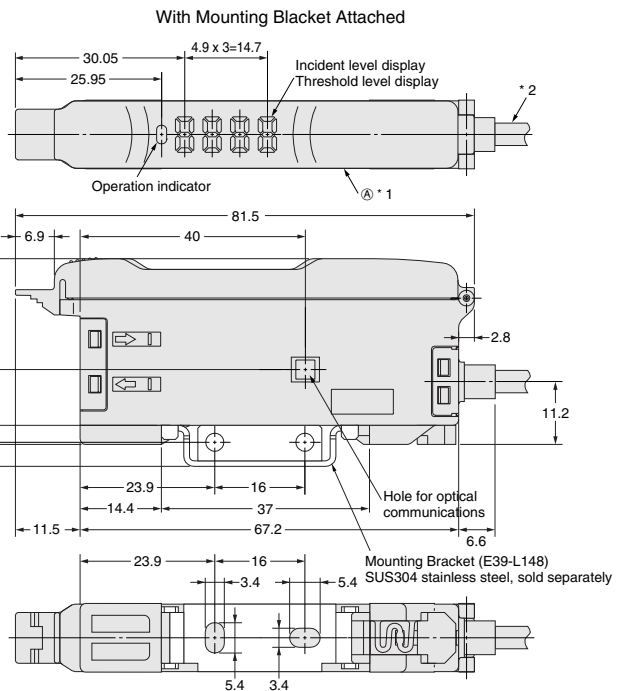
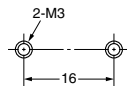

- * 1. The mounting Bracket can also be used on side A.
- * 2. 4-dia., 3-conductor, vinyl-insulated round cable (conductor cross-sectional area: 0.2 mm²; insulation diameter: 1.1 mm) is used.

Amplifier units with Cables, Twin-output Models

E3X-DA11TW
E3X-DA41TW

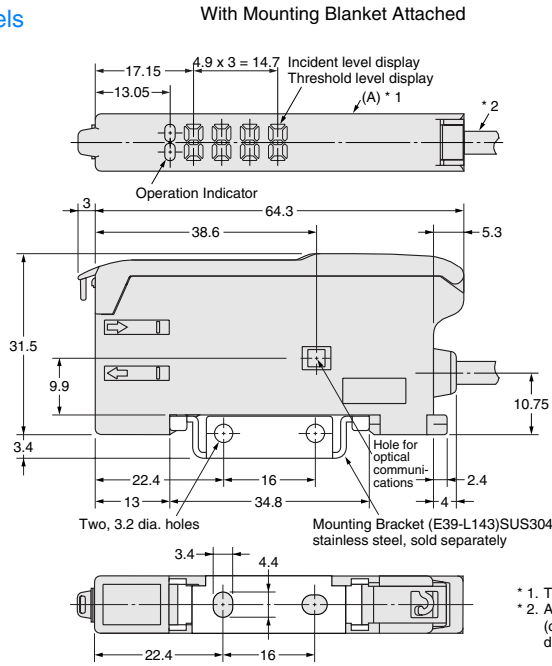
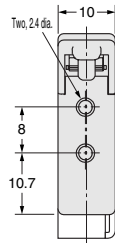
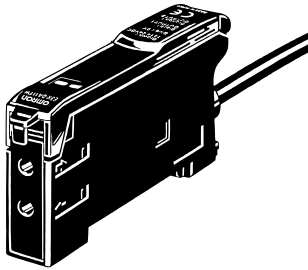

Connector type

E3X-DA6E3X-DAG6
E3X-DA7E3X-DAH6
E3X-DA8E3X-DAB8
E3X-DA9E3X-DAG8
E3X-DAB6E3X-DAH8
E3X-DA6D

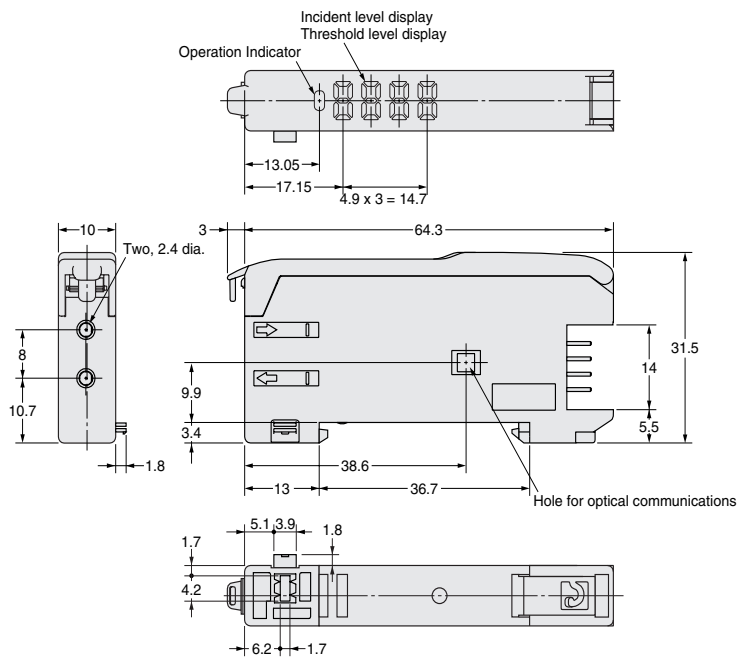
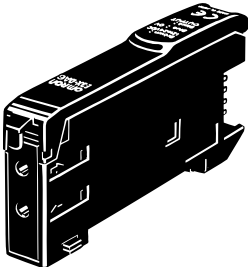

Dimensions with Master Connector Connected

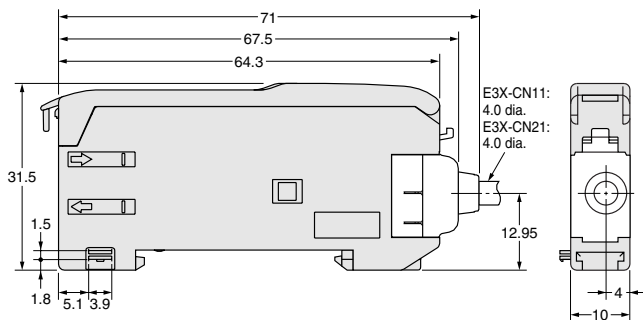

Dimensions with Slave Connector Connected

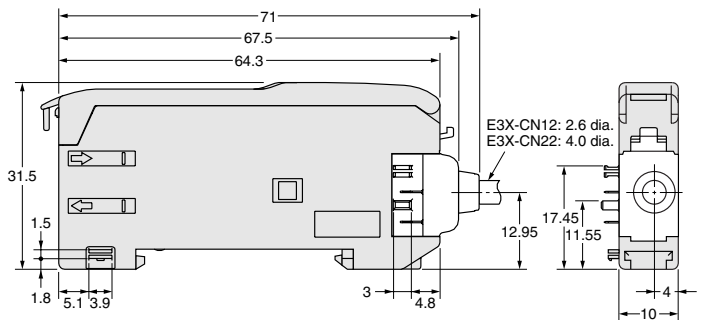

Amplifier Units M8 Connectors,
Water-resistant Models

E3X-DA14V
E3X-DA44V

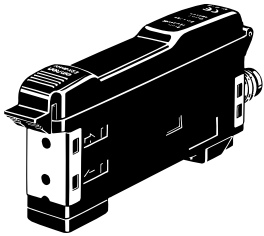

* The Mounting Bracket can also be on side A.

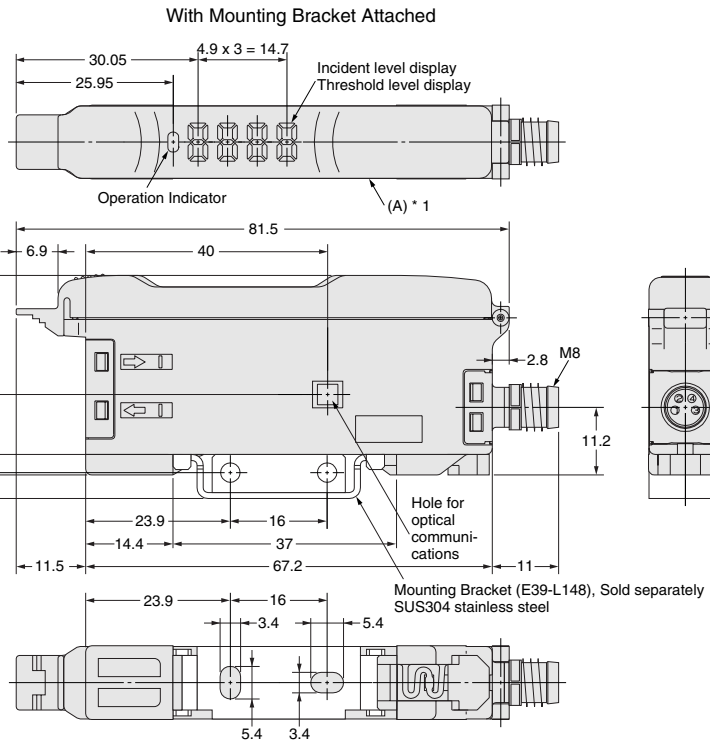
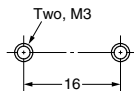
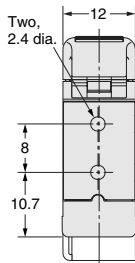

Amplifier units with Standard Connectors,
Twin-output Models

E3X-DA6TW
E3X-DA8TW

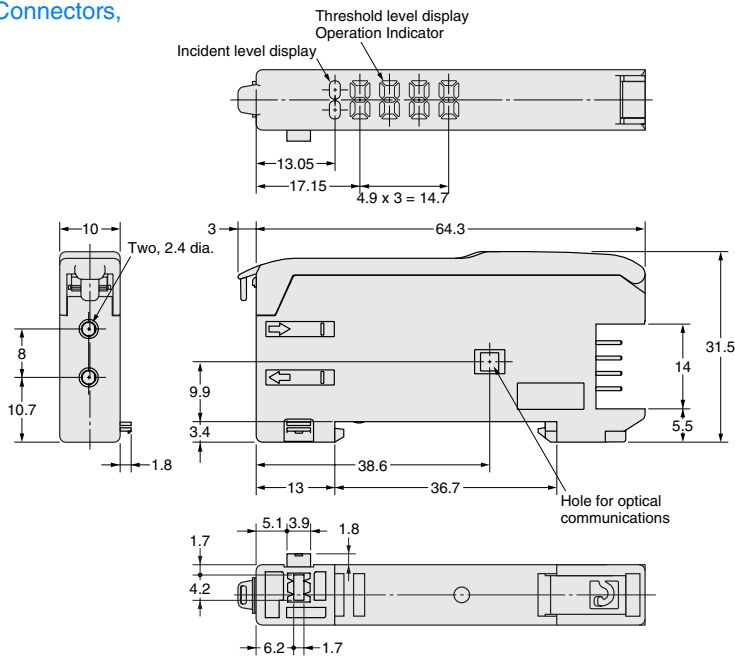
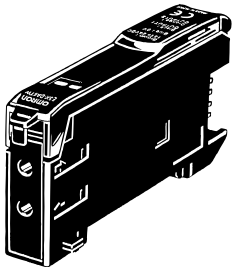

Dimensions with Master Connector Connected

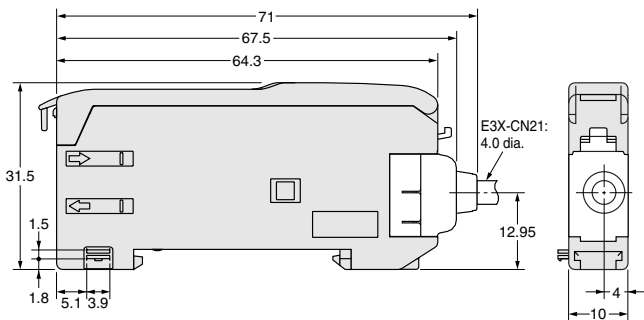

Dimensions with Slave Connector Connected

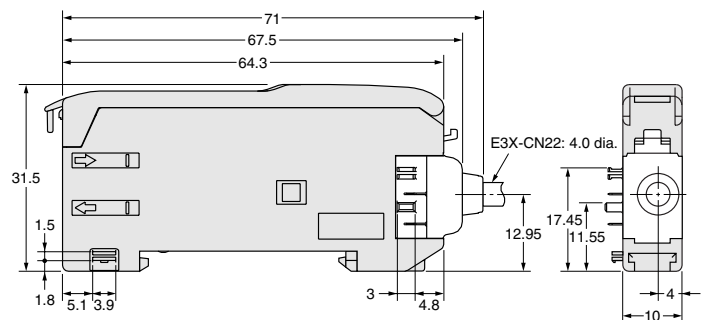

Amplifier Unit Connectors

Master connector

E3X-CN11
E3X-CN21

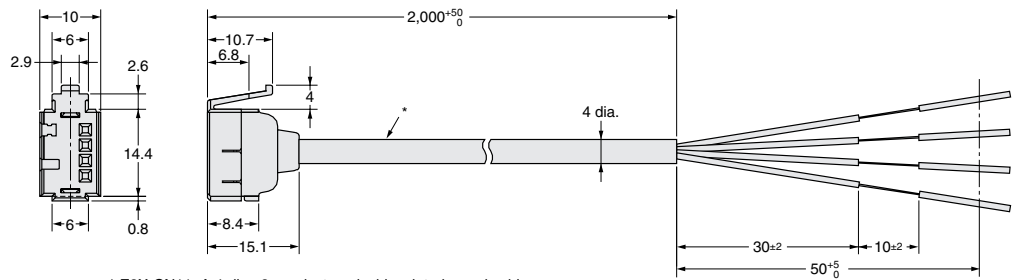
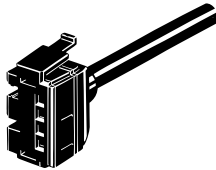

* E3X-CN11: A 4-dia., 3-conductor, vinyl-insulated round cable (conductor cross-sectional area: 0.2 mm²; insulation diameter: 1.1 mm) is used.
E3X-CN21: A 4-dia., 4-conductor, vinyl-insulated round cable (conductor cross-sectional area: 0.2 mm²; insulation diameter: 1.1 mm) is used.

Slave connector

E3X-CN12
E3X-CN22

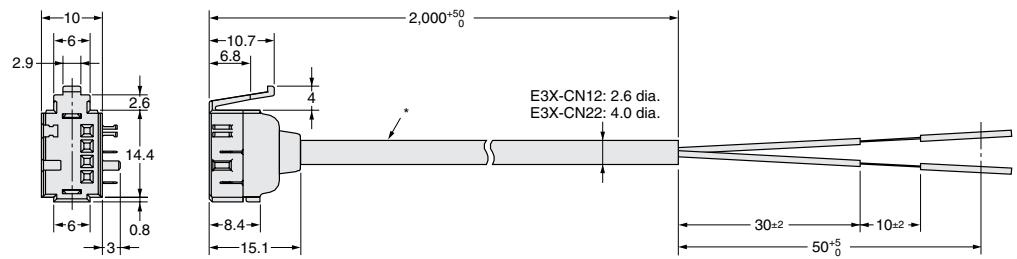
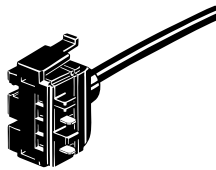

* E3X-CN12: A 2.6-dia., single-conductor, vinyl-insulated round cable (conductor cross-sectional area: 0.2 mm²; insulation diameter: 1.1 mm) is used.
E3X-CN22: A 4-dia., 2-conductor, vinyl-insulated round cable (conductor cross-sectional area: 0.2 mm²; insulation diameter: 1.1 mm) is used.

Mobile Console

E3X-MC11

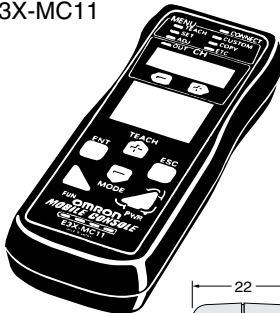

Mobile Console

AC adapter jack Communications jack

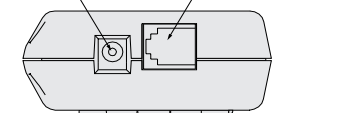

Menu indicators Connection indicator

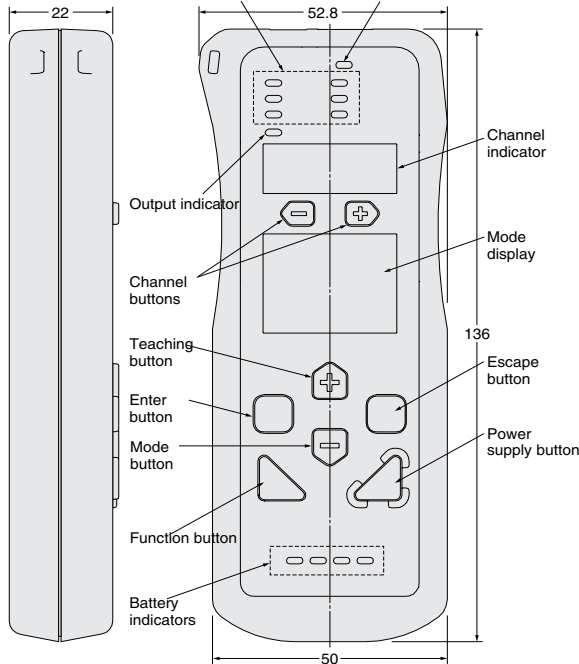

Mobile Console head

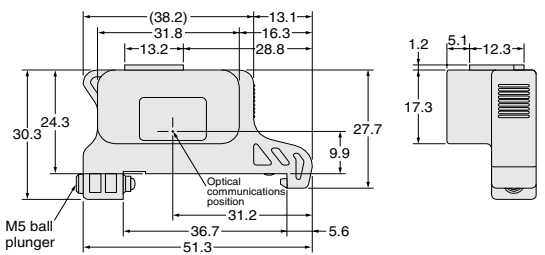
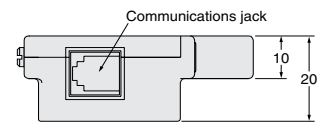
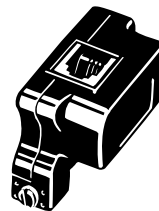

ALL DIMENSIONS SHOWN ARE IN MILLIMETERS.

To convert millimeters into inches, multiply by 0.03937. To convert grams into ounces, multiply by 0.03527.